



Mimi's Mr. & Mrs.

Gnomes/Elves/Characters

by Gloria J. "Mimi" Winer Updated 2009

These cute little 15" overweight, middle aged, pot bellied dolls with short arms and legs teach my new version on the "antique" sling button joint. They are jointed at the shoulders, hips, and knees.

There are both easy instructions for beginners and more advanced techniques for experienced dollmakers. You have many choices to customize the dolls, including shoes, ears, hands, arms, and faces.

These dolls are not armatured but can stand alone if properly stuffed.

You can make these dolls into any short, pot-bellied fantasy character that has short arms and legs. These versatile bodies will also accept hard media heads and hands.

You Have a Choice of Faces

- ✿ The 3-dimensional face has a trapunto nose, a quilting technique consisting of stitching the features to a lining and stuffing with small bits of fiberfill to define the facial contours.
- ✿ The alternate face has traced features that can be colored with colored pencils, painted, or embroidered. It is then defined with very little needle modeling.

You Have a Choice of Ears

- ✿ Pointy elf ears.
- ✿ Round human ears..

You Have a Choice of Hands

- ✿ Open finger hands with stuffed fingers.
- ✿ Open finger hands with wired fingers that can grasp things.

You Have a Choice of Arms

- ✿ Straight arm.
- ✿ Bent arm.
- ✿ One of each.

You Have a Choice of Shoes

- ✿ Pointy Elf shoes.
- ✿ Flat soled boots.
- ✿ High-heeled boots/shoes.



For more Color Pictures, please visit Mimidolls.Com

General Instructions

Mimi's **Mr. & Mrs.** pattern has two optional faces: an easy needle-modeled face and a slightly more difficult face with a 3-dimensional trapunto nose; two optional hands: an easy stuffed hand, and easy wired hand with poseable fingers; and three optional legs: one with a curled up toe (elf boot), a regular flat shoe, and a high heel shoe for Mrs.

This pattern teaches Mimi's new variation on the "antique" sling button joint. The dolls have button jointed hips and shoulders. The sling button joint at the knee enables the doll to stand (without an armature) or to sit quietly on a shelf or in a chair. However, being creatures of the forest, they prefer sitting on a tree stump or a chair made from twigs decorated with vines and flowers.

- * *Read all instructions before starting.*
- * *Follow grain lines indicated on pattern pieces.*
- * *Mark all circles, darts, and construction details as indicated.*
- * *Clip seam allowances at inner curves and notch outer curves to make them lie flat.*

About Stuffing

Airtex Premium is my stuffing of choice. It is the "Rolls Royce" of stuffing. It has no lumps or un-exploded fibers. It clings to itself which means it stays exactly where you put it. I can almost sculpt with this stuff!

Be sure to request **Premium**. (There is another silkier one that is good for other things but not for my dolls.)

This wonderful stuffing will help you to stuff very smoothly for a more professional looking doll. I use it with hemostats (6" and 8") for a professional finish.

Costumes

Mrs. costume consists of drawers, chemise, skirt and a vest made from suede cloth, Ultrasuede™ or felt that needs no facing or lining. Trim her in colorful florals, leaves or something bright. She loves bright colors.

Mr. wears breeches, a shirt tied at the neck, and a vest similar to Mrs.' vest. However, he likes more somber colors that allow him to hide in the forest until he is sure he wants to meet you.

Ultrasuede is sold by the inch in most fabric shops. Seven inches will make many doll vests. (It is 45" wide).

You Can Sell Dolls Made From This Pattern

When the doll is completed add the copyright symbol (a C in a circle ©), my name "Mimi," your name as dollmaker, and the date. You can sell as many dolls as you can make *entirely by yourself* as long as you don't set up a factory.

About Muslin

I use **Southern Belle** unbleached muslin made by **Spring Mills**. It is a close weave, high thread-count (240) fabric. It has less stretch than **Rangefinder** or **RocLon**.

If you use muslin other than **Southern Belle**, your doll will be a little more zaftig. I chose a tightly woven fabric that will not stretch much so that they will not appear heavier than I wanted them to be.

Be aware that if you choose another fabric you may have to adjust the clothing patterns accordingly.

Read All Directions Before Beginning

- * *There are no seam allowances on any of the pattern pieces, except the hat. Read hat directions carefully before cutting.*
- * *Take the time to make templates. It is easier to make more than one doll at a time with templates and your pattern will last longer. Using templates will allow you to precision stitch directly on the sewing line, so that your doll will have the shape it was designed to have.*

- * *If you want to change the size of the doll, enlarge or reduce it as a template. That way, the seam allowances don't get larger or smaller with the size of the doll.*
- * *To make the doll stronger, stitch a second seam exactly over the first one. (This will prevent the seams from popping when you stuff as firmly as I do.)*
- * *The thread should be one to two shades lighter than the fabric so that there is no build up of color from double stitching to show on the right side of the doll skin.*
- * *Use your clear plastic appliqué foot. (Some older machines have a metal foot that has one short side, this works well too.) It is important to be able to see the purple line in FRONT of the needle. These subtle "nuances" in the seams give the doll its wonderful shape.*
- * *Use the straight stitch feed cover plate (the one with the single small hole). If you don't have one, ask your dealer to order one for you. The straight stitch feed cover plate will keep your machine from eating your fabric when rounding tiny places like fingers and toes.*

- * *If you can't get a straight stitch feed cover plate, or while you're waiting for one, place a small piece of masking tape over each side of the wide zigzag hole (while the needle is in the down position so you know where to put the tape). Be sure to check the masking tape frequently as it comes off easily.*

To Make Templates

- To make templates, roughly cut out and glue the pattern pieces to used file folders.
- Cut out the cardboard-backed pieces on the black lines.
- Cut away all the darts so you can mark the darts perfectly on the fabric.
- Use a small (1/8-inch) hole punch or push a pencil point through the circles (or dots). Mark the circles onto the fabric to show the starting and stopping points of your stitching lines.
- * *(There are several places that are left open for easier stuffing. These tiny circles will remind you to stop stitching.)*

To Use the Templates

- To use the templates, draw around the pattern pieces directly onto the fabric with the air soluble marker. This is the stitching line.
- Using the **Dream Seamer**, trace around the template again. This is your cutting line and will make perfect 1/4" seams.

- After cutting out a pair of pieces, turn them over and trace the stitching lines on the other side.

→ Attention

IMPORTANT: Be sure to stitch from the edge of the fabric, across the seam allowance, down the purple stitching line, across the seam allowance, and off the edge of the fabric ON ALL SEAMS.

Dream Seamer

A **Dream Seamer** is a small brass button with a hole in the center. The manufacturer has discontinued it, so you need to look for the **Dritz** version or try one of the on-line sources listed later. **Dritz** can often be found in the notions department of your fabric or craft shop or at DollmakersJourney.com.

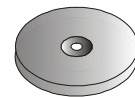

When you put your marking pen in the button's hole and draw around your template you are drawing a perfect quarter-inch seam allowance.

A Few Hints

- * *If the tip of your marking pen doesn't fit the hole well enough to mark the fabric, use your small sharp scissors and snip a point on the felt tip of the marking pen. OR, use a sharp pencil instead since you are marking the cutting line and it will be cut off anyway.*

- * *Several pieces can be stitched before cutting. Since this is easier than stitching after cutting, read the instructions carefully to see where you can do this.*
- * *Stitch these pieces before you cut them out leaving a 1/4" seam allowance all the way around the piece.*
- * *When following the stitching lines with your sewing machine, bring the stitching all the way to the end of the seam allowance and off the edge of the fabric. Do not stop at the next stitching line. **This is very important.***
- * *After cutting out a pair of pieces, turn them over and trace the darts and stitching lines on the other piece.*
- * *If you bleed on the doll, use your saliva to clean away the stain. The enzymes are the same as those in your blood and will wipe away the blood. (This only works with your own blood.)*
- * *Use the check-off boxes and circles to keep track of what you have done and not done the first time.*
- * *Instructions have a square box in front of them. Steps within an instruction have a circle in front of them.*
- * *Just ✓ or ✗ the boxes and circles as you go.*
- * *Hints or notes have a pencil  or daisy * in front of them and are in italic (slanted) type.*

Get Ready, Get Set . . .

- Change your machine needle unless it's new. Use a #8, #9, or #11 for light to medium weight woven fabric, or use a universal needle.
- Set your machine for 20 to 24 stitches per inch. This is 1.5 mm on my **Pfaff** or #3 on the **Singer 2010**. If your machine does not have an obvious setting, here's how to do it:
 - Set your machine for a smaller stitch than you regularly use.
 - Stitch and count 20 or 24 stitches on a scrap of fabric.
 - Measure the stitches.
 - Change the size of the stitch until this number of stitches measures one inch.
 - Use a spot of nail polish or Whiteout® to mark this setting on your machine so you can find it next time you are stitching a doll skin.
- Clean all the fuzzies out of your machine.

Now, Let's Make a Doll! ! !

Making the Face

If this is the first time that you are making a doll from this pattern, I recommend that you do things in the order that they are presented.

The work has been carefully arranged so that the simplest things are first, and so that you can use what you learn at each stage to make later stages easier. After you have done a few of these dolls, you can work in any order you find easiest.

* *Start by making the face so that you will have inspiration to finish the doll. You can make as many faces as you want until you make one that you like.*

You have a choice of two faces:

- * The primary face has a trapunto (stuffed) nose and the rest of the face is needle-modeled.
- * The alternate face is traced and colored with pens, pencils, or crayons, or embroidered.

The special, easy eye painting instructions can be used for either face.

Making the Alternate Face

- □ Place the **Alternate Face** template (pattern piece 1A for Mr. or 2A for Mrs.) on a single piece of muslin. Make sure the grain arrow on the pattern is along the length of the goods parallel to the selvage (side) edges. (The face is cut on the bias for more flexibility in needle-modeling.)
- Trace around the template with the air soluble pen.
- Using the **Dream Seamer**, add seam allowance all the way around.

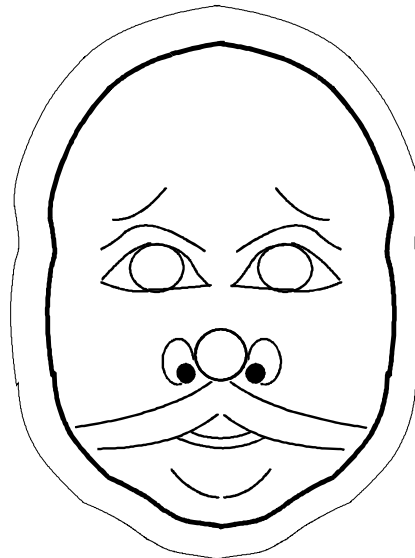

- Using a pencil, or a fine-tipped brown fabric pen, trace the features on the right side of the muslin.
- Color, paint, or embroider the features.

- * *If you are planning to embroider the face, do it before you cut out the face, so you can fit it into your embroidery hoop. The embroidery instructions are in Appendix B at the end of this instruction book.*
- Cut the face out on the cutting line.
- * *If you are planning to paint the eyes using the easy eye painting instructions, do it after you cut out the face, but before you continue with the gathering threads. The easy eye painting instructions are in Appendix B at the end of this instruction book.*
- Stitch a gathering thread around the face on the stitching line. **Use a normal machine stitch, not a basting or other long stitch.** Begin at the center top of the head and stitch around the face on the purple line. End one or two stitches from where you began.
- Cut the threads leaving 3-inch tails.
- Stitch a second line of gathering thread halfway between the first line of stitches (on the purple line) and the outside edge.
- Gently pull both bobbin (bottom) threads on one side and gather the face to the center of the chin. Pull the bobbin threads on the other side and gather the other side to the chin.

* Notice that two lines of gathers, made with small stitches, make less wrinkles in the face than a single line of gathers.

- Put some stuffing in the face and set it aside to be "installed" later.

We will do some needle modeling after the face is pinned in place on the body head stump.

→ Attention

Be sure to set your machine back to 18 to 20 stitches per inch before continuing.

Primary Face with Trapunto Nose

- Place the Primary Face template (pattern piece 1 for Mr. or 2 for Mrs.) on a doubled piece of muslin. Trace around the face.
- Using the **Dream Seamer**, add seam allowance at back of face and under chin only.

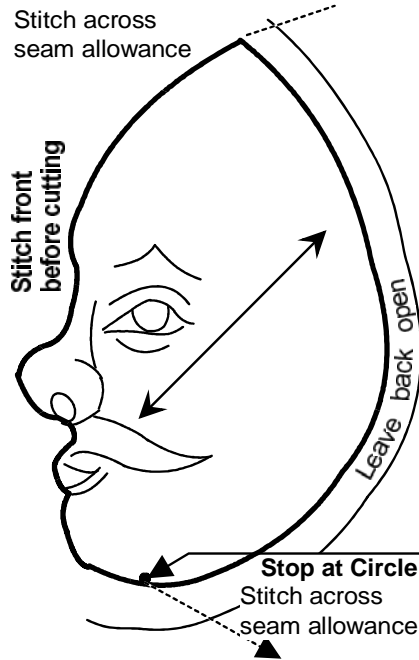

→ Attention

Stitch before you cut. It is important to stitch across seam allowance at the top edge of fabric and after reaching the circle below the chin.

- Stitch across seam allowance at the top, down the center front seam to the circle below the chin, and across seam allowance below chin.
- Turn over and stitch again exactly on the first stitches.
- Trim the seam to 1/8 inch. Snip seam at bridge of nose, under the nose, and at the lips.
- Right sides together, slip the Primary Face (pattern piece 1 for Mr. or 2 for Mrs.) into the face. Push the template against the seam and trace the nose, and the rest of the features.

- Remove the template and push in the Primary Face Trace (pattern piece 1T for Mr. or 2T for Mrs.). Turn the face over and trace the features of the other side of the face.
- Turn the face right side out and trace the features on it, on both right and left sides.
- If you are planning to paint the eyes using the easy eye painting instructions, do it now. The easy eye painting instructions are in Appendix B at the end of this instruction book.
- Cut a one-inch square of muslin and pin it behind the nose area on the inside of the face.
- Use a single strand of regular sewing thread, knotted at one end, and a regular sewing needle.
- Put a little bit of stuffing between the face and the nose lining.
- Using your forefinger to hold the lining in place, push your needle in from the back and come out at one side of the bridge of the nose.
- Then, using tiny stitches, stitch back and forth across the bridge of the nose down to the top of the nostrils. Do not close the top of the nose.

- Take tiny stitches up-and-down around the nostrils to hold the face and the nose lining together. Leave enough space to insert the stuffing tool. (See next instruction.)
- When you've stitched all around the entire nose area, take your stuffing tool and stuff the nose fairly firmly.
- * *I recommend **Barbara Willis' Miniature Stuffing Fork** for this job. (Ordering information is given in the sources section.) It is so thin that it can get tiny bits of stuffing in places nothing else will. Use caution because the end of this tool is sharp, do not push strongly enough to push the tool through the fabric.*
- Wrap some stuffing around the stuffing tool like a cotton swab. Slip it into the outside of each nostril. Stuff the outside of the nostrils firmly or they will disappear when the rest of the nose is stuffed.
- Next, stuff the tip of the nose firmly.
- Finally, add more stuffing to the rest of the nose if necessary.
- Stitch a gathering thread around the face on the stitching line. *Use a normal machine stitch, not a basting or other long stitch.* Begin at the center top of the head and stitch around the face on the purple line. End one or two stitches from where you began.
- Cut the threads leaving 3-inch tails.
- Stitch a second line of gathering thread halfway between the first line of stitches (on the purple line) and the outside edge.
- Gently pull both bobbin (bottom) threads on one side and gather the face to the center of the chin. Pull the bobbin threads on the other side and gather the other side to the chin.
- * *Notice that two lines of gathers, made with small stitches, make less wrinkles in the face than a single line of gathers.*
- Put some stuffing in the face and set it aside to be "installed" later.

We will do some more needle modeling after the face is pinned in place on the body head stump.

→ Attention

Don't forget to reset your sewing machine to 18-20 stitches per inch.

Cutting and Stitching the Body

Lower legs

Mr. & Mrs.' lower legs have been designed as if they were wearing boots or shoes.

You have a choice of making any of three legs: elf shoes (pattern piece 12), ordinary shoes (pattern piece 10), or high-heeled shoes (pattern piece 11).

Whichever leg you have chosen:

- Place the template (pattern piece 10, 11, or 12) on a doubled piece of muslin. Make sure the grain arrow on the pattern is along the length of the goods and parallel to the selvage (side) edges. Trace around the template with the air soluble pen.

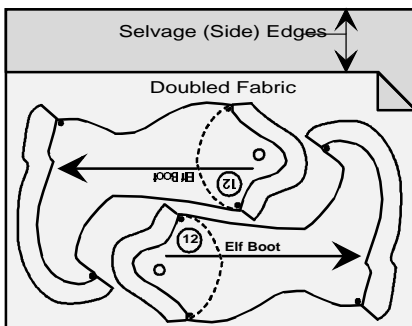

- Using the **Dream Seamer**, add seam allowance at the top of the leg, and at the bottom of the shoe only.
- Trace a second copy for the other leg.

- Using the **Dream Seamer**, add seam allowance at the top of the leg, and at the bottom of the shoe for the second leg. **Do Not Cut Out.**

→ Attention

Stitch before you cut! Stitch across the seam allowance, down the front or back of leg, and across the seam allowance before stopping. This is very important!

- Sew down the front of the leg and the back of the leg only. Repeat for the other leg. Sew to end of seam allowance.

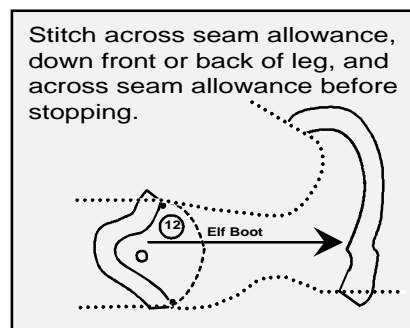

- Sew a second time, exactly on top of the first seam.
- **For high heel shoe only** After sewing the front and back of the leg, sew the bottom and inside of the heel.

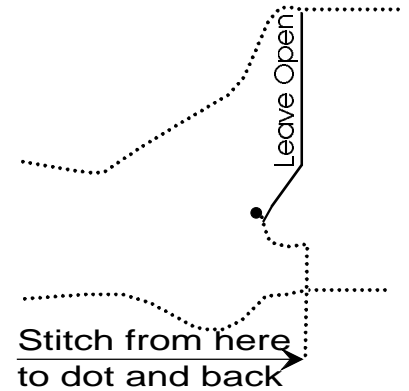

- * For a professional look, start at the back of the heel, stitch across the seam allowance to the inside of the heel, turn the work and stitch to the top of the heel, turn the work around, and stitch back to starting point.

→ Attention

Leave the top of the leg and the bottom of the foot open.

- Cut out legs, leaving a ¼-inch seam allowance at the top of the leg and at the bottom of the foot as shown in the next picture.
- Trim seams to 1/8 inch at the side as shown in the next picture.

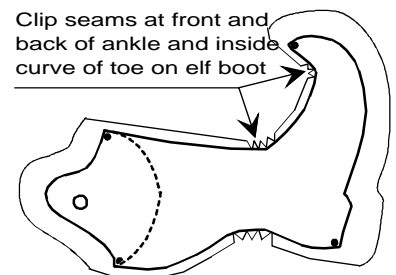

- Clip seams at the front and back of the knee (and inside the toe of the elf boots) as shown in the previous picture.

Foot

Be sure you have selected the correct sole to match the leg you have chosen.

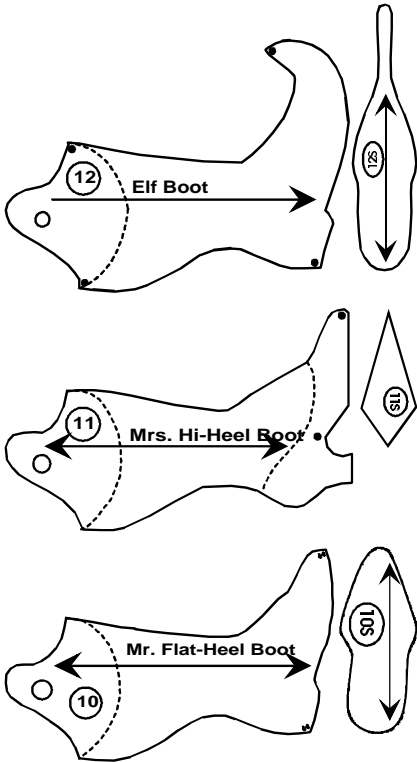

The sole templates have the same numbers as the boot templates with an "S" on the end. For example, Mrs. High-Heel Boot is pattern piece 11 and the matching shoe sole template is pattern piece 11S.

- Place the Sole template on a single piece of muslin. Trace around the foot sole template with the air soluble pen. Using the **Dream Seamer** trace around the foot sole again.
- Repeat for the other foot.

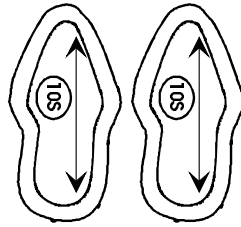

- Cut out on the cutting line.

→ Attention

Read the following paragraphs carefully and look at the pictures. Think about what you are going to do before you do it!

- Look at the following picture.

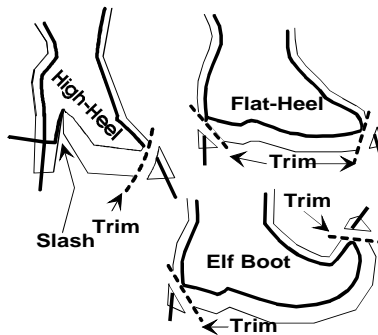

- Trim away almost all of the seam allowance on the leg center front seam and on the center back seam. This will prevent a "glitch" at the toe and the heel.

→ Attention

The leg is still inside out. Do not turn it yet.

For the Elf Boot and the Mr. Flat-Heel Boot Only

(Instructions for Mrs. High-Heel Boot are given later.)

- Make a series of slashes in the seam allowance along the bottom of the foot where it will join the sole. This will allow the foot to easily fit around the shoe sole.

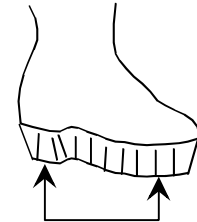

Clip across seam allowance for easier pinning. Do not cut as far as stitching line.

- Pin the sole to the leg bottom.
- * *Begin by pinning at the toe (center front seam) and heel (center back seam). Then work around to the sides.*
- * *You may hand baste this seam if it makes you more comfortable.*
- Stitch first on the bottom of the foot.
- Begin to machine stitch at the side, not at the center front seam or at the center back seam.**
- Stitch VERY slowly. Stitch exactly on the purple line. When you get to one of the center seams:
 - With the needle down, lift the pressure foot. Then flip the leg to the back of the machine (away from you) and continue to the next seam.
 - Repeat when you reach the other seam.

- Since you have removed almost all of the seam allowance in the stitching area there should be no glitch when you examine your seams.
- Remove the leg from the machine. Check the other side to be sure you have not stitched below any of the slashes you made on the foot.
- Now, foot side up stitch again directly on top of the first line of stitches, ignore any purple lines on this side of the foot.

For the Mrs. High-Heel Boot Only

(Instructions for the Elf Boot and the Mr. Flat-Heel Boot were given previously.)

- Lift one side of the foot out of the way and pin it. Then put a pin through the toe of the sole and through the toe of the foot to align them.

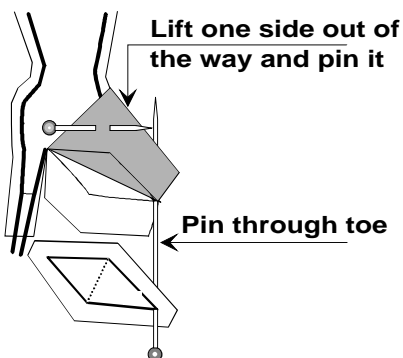

- Pin sole to the "down" (unfolded) side of the foot, lining up the heel end of the gusset with the inside of the heel.

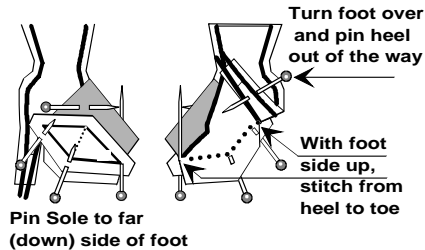

- Turn the foot over and pin the heel out of the way.
- Stitch on the purple line on the foot side from the back of the sole to the toe. Remove any glitches.
- Remove the pins. Pin up the stitched side of the foot and pin the sole to the other side of the foot.
- Turn the foot over and pin the heel out of the way.
- Stitch on the purple line on the foot side from the back of the sole to the toe. Remove any glitches.
- Turn the bottom (sole side) up. Starting at the back on one side, stitch a second time exactly on top of first stitches.

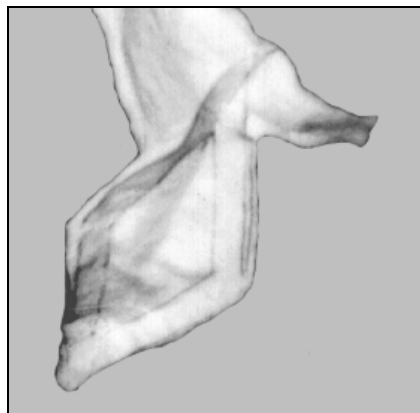

Mimi's Mr. & Mrs.

- Stop at the toe and push the leg out of the way. Then continue around to the back on the other side.
- * *Ignore the purple line. Stitch directly on top of the existing stitches.*
- * *Be very careful not to catch the side of the foot in the stitching.*
- When you are done, stitch the corner at the top of the heel a couple of times from the side.

For all Boots

- Clip the threads. Trim the seams to 1/8 inch. Clip the seams almost to the stitching to make turning easier.
- Put **Grrrip** glue on all seams. Turn while the **Grrrip** is still wet.
- Using the hemostats, turn the heel like you turn a finger. Then grab the toe with the hemostats and turn the leg.
- * *If there seems to be a glitch near the top inside of the heel after turning the foot, turn it back and clip closer to the seam, then try turning again.*

Facing Top of Lower Leg

The Boot Facing is used to make a "pocket" to hold plastic inserts that make the knee action smooth.

- Place the template (pattern piece 9) on a doubled piece of muslin. Trace around the template with the air soluble pen.

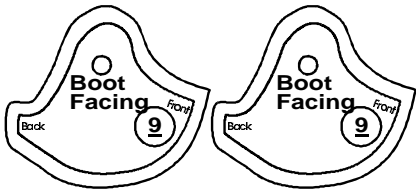

- ❑ Using the **Dream Seamer**, add seam allowance all the way around.
- ❑ Trace a second copy for the other leg.
- ❑ Using the **Dream Seamer**, add seam allowance all the way around. **Do Not Cut Out.**
- ❑ Stitch the two pieces together across the front and back seam allowances **only**.

Stitch across seam allowance at back and front only.

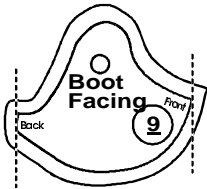

➔ **Attention**

Stitch before you cut!

- ❑ After stitching, cut out the facings.
- ❑ Stretch the facings over the boot tops with the right sides together. (The boot is right-side out and the facings are right-side in.)
- ❑ Pin the facing to the top of the boot.
- ❑ Stitch along the top stitching line.

Stretch facing over boot top, right sides together. Stitch top seam. Then trim closely and clip curves.

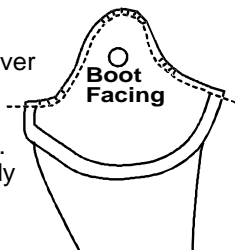

- ❑ Trim away most of the seam allowance that you just stitched and clip the curves.
- ❑ Fold the facing inside the boot and top stitch very close to the edge on the right side. (This will keep the facing from turning inside when you bend the doll's knee.)

Turn facing inside boot top and top-stitch to make pockets inside boot top for plastic inserts.

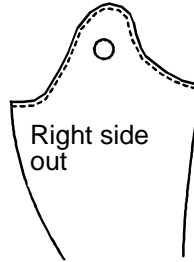

Plastic Inserts

The plastic inserts make the doll's knee action operate smoothly.

- ❑ Using the Boot Facing template (pattern piece 9) trace four plastic inserts on the top of a Cool Whip™ container or one of similar thickness. Cut the inserts out using a utility or paper scissors.
- * *Do not use your sewing scissors to cut plastic. It will ruin the edge for cloth.*
- ❑ Using a hole punch or a craft knife, punch or cut a hole in each insert where indicated on the pattern so that you can stitch through it.

- ❑ Slide an insert into the pocket between the upper leg top and the facing. Now slip in a second insert on the other side. (This is not easy but it can be done with a small amount of effort — and a lot of patience.) Push the inserts into place and be sure the facings are pushed down straight and not caught under the plastic.

- ❑ Using a short needle and regular hand sewing thread, top stitch by hand around the bottom of the insert to hold them in place. (Stitch through the boot and facing.) You can feel the the bottom of the insert through the fabric.

Plastic insert in pocket.

Top-stitch by hand below inserts to lock them into the pockets.

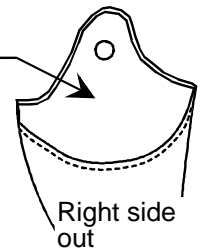

* *Those of you who quilt by hand will want to use your between needle and "rock the needle" for a nice even quilting stitch here.*

- ❑ Do the other leg.

Upper Leg (Thigh)

- Place the template (pattern piece **5**) on a doubled piece of muslin. Make sure the grain arrow on the pattern is along the length of the goods and parallel to the selvage (side) edges. Trace around the template with the air soluble pen.

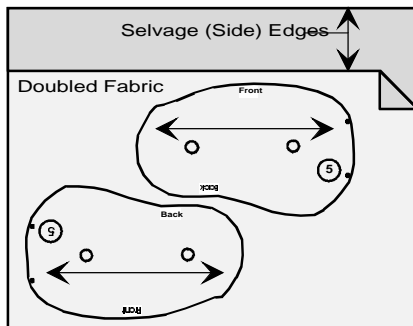

- Trace again for the other leg.

→ Attention

Stitch before you cut!

- Stitch from one dot around the long side to the other dot. Leave open between dots for stuffing.
- Cut out leaving a 1/8-inch seam allowance. (Leave more —1/4-inch — at the opening.)

Hands and Arms

You have a choice of bent or straight arms, or one of each. The bent arms are pattern piece **4B** and the straight arms are pattern piece **4S**.

- Place the template (pattern piece **4B** or **4S**) on a doubled piece of muslin. Make sure the grain arrow on the pattern is along the length of the goods and parallel to the selvage (side) edges. Trace around the template with the air soluble pen.

- * *Making sure the grain arrow on the pattern is along the length of the goods places the fingers on the bias, allowing you the stretch you need to turn the fingers.*

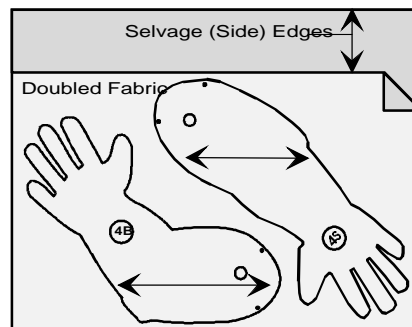

→ Attention

Stitch before you cut!

- Stitch from one dot around the long side to the other dot. Leave open between dots for stuffing.
- * *Make the lines between the fingers just a tiny bit deeper. The template causes the fingers to be a tad shorter than I like to make them. (Fingers should be as long as the palm of the hand.)*
- * *Stitch very slowly and carefully around the fingers. Keep stitches just inside purple lines. There should be at least two tiny stitches between each finger.*

- * *Pivot every 2 or 3 stitches as you round the finger tips. (To pivot, lift pressure foot, with the needle down and turn the fabric slightly, put pressure foot down and stitch another couple of stitches and repeat until you have rounded the finger.)*

- * *When you get to the area between the fingers, pull fabric toward you slightly so you can stitch several times in the same place. You want a minimum of two stitches between each finger. By not allowing the fabric to move you can get several stitches in the same space.*

- * *Pivot and stitch up the length of the next finger.*

- Cut out the arm and hand leaving a 1/8-inch seam allowance. (Leave more —1/4-inch — at the opening.) **Do not cut between the fingers yet.**

- Be very careful cutting out the fingers. Follow the directions exactly.

- Cut on the side that does NOT have purple marks, it's easier to see the stitches.

- With small sharp scissors, slice between fingers as close to the center of the narrow space as possible. Snip very close to the stitches between the fingers or it will not turn properly. Trim around the tips of the fingers. The seam allowance will be very narrow, not much more than 1/32-inch.

Turning the Fingers

I recommend using a hemostat for turning fingers. It's faster and the risk of damage to the fabric is less than with some of the other turning tools on the market.

Mr. & Mrs. hands are larger than my other dolls and a 5 or 6-inch straight Kelly hemostats will do the job.

- * *When you are looking for these tools look for the longest, thinnest jaws you can find. Even in the same box of hemostats some of the jaws are thinner than others.*

To turn the fingers, follow these steps:

- Fold the arm down into a cuff, like a glove.
- While holding one muslin finger between your thumb and forefinger, gently insert jaws of a hemostat into the finger.

- Open the jaws slightly and use your fingernail to push a tiny bit of the seam allowance at the tip of the finger into the jaws.
- Lock the jaws. Dampen your own thumb and forefinger, (I lick them) Then, protecting the muslin finger by holding between your damp thumb and forefinger, gently twist jaws of hemostat until finger is turned into palm.
- Turn all fingers this way.
- Now, grasp any finger with the jaws of the hemostat, pull on the cuff, and presto, the hand and arm is right side out. I bet you thought it would be more difficult than that.

* *If you poke a hole in the finger, all is not lost, but you will have to wire the finger to recover it. Stuff with chenille stems or hand armature as explained later. When you're finished, spread a little white glue over the tear and smooth it. It hardly shows at all.*

- Close the jaws of the hemostat and gently push the end of each finger to spread the seams out. Protect the muslin finger while pushing by holding it between your thumb and forefinger.

Torso

The torso is made from six pieces to give it side-to-side symmetry while it has front to back differences. Mrs. breasts are made separately and attached to the torso front after the torso has been stuffed and closed..

- Place the Body Front gusset template and the Body back gusset template (pattern pieces **7** and **8**) on a doubled piece of muslin. Make sure the grain arrow on the pattern is along the length of the goods and parallel to the selvage (side) edges. Trace around each template with the air soluble pen.
- Trace around templates for Body Front Gusset and Body Back Gusset a second time using the **Dream Seamer** to mark the cutting line.

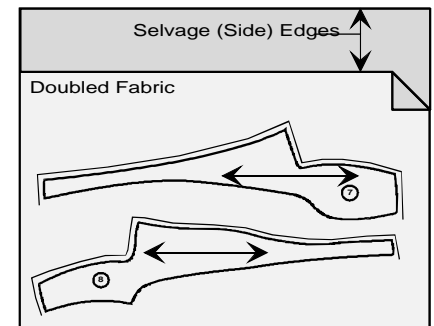

→ → Attention

Stitch before you cut!

- Stitch the center front seam and the center back seam before cutting.

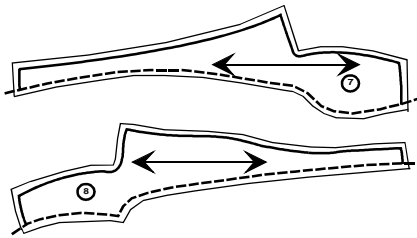

- Place the Body Side template (pattern piece 6) on a doubled piece of muslin. Trace around it with the air soluble pen. Trace around the template again using the Dream Seamer.

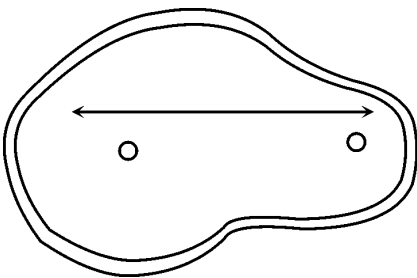

- Cut out body side on cutting line.

Assemble Body

- Right sides together, pin body front gusset to body back gusset at shoulders and crotch.
- Stitch.
- Stitch a second time directly on top of the first line of stitching.
- Trim shoulder and crotch seams.

Note

The body gusset is left open at the top of head stump for stuffing.

- Make sure the body gusset is inside out.

- Right sides together, carefully pin body side to one side of assembled gusset, matching the shoulder and crotch seams to small dots on body side.

Attention

Be sure the body side tummy is pinned to front gusset and the body side back is matched to the back gusset. The smooth curve is the tummy. Look at the pattern piece if you are not sure which side is which.

- Stitch
- Stitch a second time directly on top of first line of stitching.
- Pin and stitch other side.
- Trim all seams clipping and notching as necessary.
- Turn right side out through opening at the top of the head.

Making the Ears

- Place the template (pattern piece 3E for elf ears or 3H for human ears) on a doubled piece of muslin. Trace around the template with the air soluble pen for each ear.

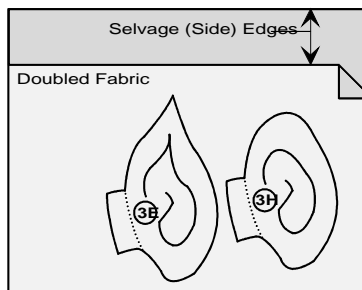

Attention

Make both ears the same — elf or human.

Attention

Stitch before you cut!

- Stitch from one side of the tab around the ear to the other side of the tab. Leave tab open for stuffing.

Attention

Do not stitch the line inside the ear at this time.

- Cut out leaving a 1/8-inch seam allowance.
- Turn ear right-side out through tab opening.
- Put a small amount of stuffing inside ear.
- Draw the inside line on the ear with the air soluble pen.
- Stitch on the inside line, either by machine or by hand.
- Put ears aside for later.

Stuffing the Body

Stuffing a doll is an art all by itself. Several dollmakers have written books about it. Of course, we all have our own techniques, and none of us do it quite the same way. If you want this doll to come out really well, try doing it my way.

How to Stuff: The Nesting Technique

→ Attention

While it is possible to do this with your fingers, it is easier to do this with a hemostat.

Always nest the stuffing for a smooth skin. Each time you put more stuffing in the doll, hollow out the center like a nest with your fingers or by opening and closing the jaws of the hemostat. Then put more stuffing into the hollowed-out center.

Think of it this way: if you put a bunch of tennis balls into a sock, you'd have a lumpy sock. But if you cut the tennis balls in half and then stacked them inside one another, the surface would be smooth and strong.

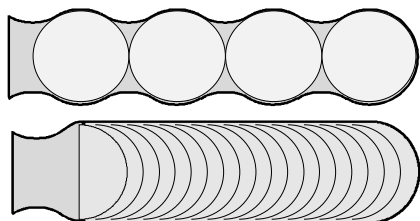

* *File your nails smooth before starting. It helps prevent snags. If you keep your nails short, your fingers won't hurt as much from the work of pushing in stuffing.*

The doll should be stuffed firm but not hard. It should feel about as firm as a ripe slicing tomato. If you just stuff it as full as you possibly can, and then add about ten percent more, it should be almost firm enough.

Touching Up the Stuffing

It is much easier to make a doll if you have the right tools. The most important tools for a dollmaker (after the sewing machine) are the stuffing tool and the hemostat.

I make my stuffing tool from a **Stanley #64-846** screwdriver. It is about 6 inches long with a straight blade about 1/8-inch wide. The blade has straight sides without any little "ears."

The Stanley screwdriver has a plastic handle. I drill a hole length-wise in the end of the handle and use a double-ended dowel screw to attach a large, round, wooden drawer-pull knob to make it fit my hand comfortably.



This is the kind of screwdriver that they use for those little screws on the back of a computer, so you may be able to "borrow" one from somebody who uses a computer. You can use the screwdriver just the way it comes from the store, or you can add the knob to make it more comfortable.

I wrap a small amount of stuffing around the tip to stuff fingers and make knuckles. I can slip a larger amount of stuffing underneath the doll's skin to fill in soft spots, even after I have finished sculpting. (It fits between sculpting threads.) I can also use it to reach under the doll's skin to straighten or align seams.

A medium sized hemostat (clamp or forceps) is useful for turning fingers, inserting foot plates, inserting wads of stuffing, inserting pom-poms, and removing stuffing. You can get them at any surgical supply store and at some **Radio Shack** stores.

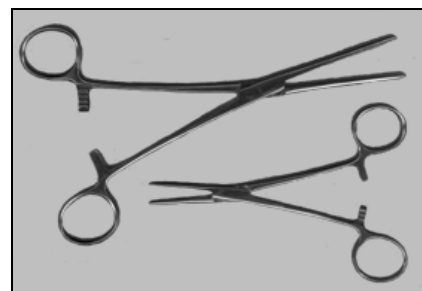

Ideally, you should have several in different sizes. If you only get one, get a medium size (5 to 8"). Look for long, thin, straight jaws. The 6", straight Kelly hemostat is my favorite.

The hemostat is particularly useful for stuffing around an armature where your fingers won't fit.

- Take a wad of stuffing in the jaws and insert the stuffing into the doll.
- Unlock the jaws and pull the hemostat back away from the stuffing.
- Close the jaws and push them into the center of the wad.

- Open and close the jaws while twisting the hemostat to hollow out the center into a nest.
- Then put more stuffing into the middle and do it again.

Stuffing the Body

- Turn the body right side out.
- Stuff the body using your hands where you can and the tools where necessary. The body should be quite firm, almost hard
- Shape the body with your hands as you stuff.
- Use your hemostat to stuff the head. Shape it with your hands from the outside as you stuff.
- * *The basic techniques for stuffing are discussed on the previous page.*
- * *Stuff the head stump and neck almost hard. Wrinkles in the neck will stuff out.*

Closing the Head

- Run a line of gather stitches around the top of the head stump about 1/8 inch from the top of the head.
- Pull the threads to close the top of the head. Use the stuffing tool to insert more stuffing if needed before tying off the thread ends.
- * *To avoid cutting your hand, you may want to put a bandage or some adhesive tape on your index finger or wherever the thread might cut.*

* *Before completely closing the body check to see if you need to add more stuffing. Add as much stuffing as necessary to make the bottom nicely round and firm. (The hemostat will put stuffing in the bottom by slipping it under the skin even after the doll is stuffed.)*

- After tying off the threads, put the ends in a needle and lose the ends inside the body.
- Put **Grrrip** glue on the closed seam for added strength.

Ladder Stitching

The ladder stitch is used to close all stuffing openings and to attach the doll's breasts. It's called the ladder stitch because the stitches look like a ladder until you pull the stitches tight to close the seam. Pull every four or five stitches as you stitch. Use a very strong 100% nylon drapery thread usually found in the home dec department of your fabric shop.

- Mark around the edges of the opening so that you will stitch evenly.
- * *The fabric distorts as you stitch. If you don't mark the stitching line, you won't be able to figure out where the stitches go.*
- Knot the end of the thread and start from inside the opening so that the knot will be hidden.

- Turn the raw fabric edges inside the opening as you stitch.

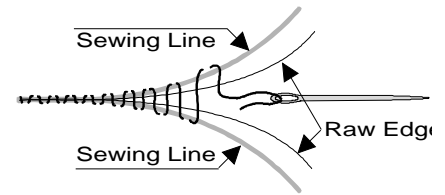

- End the stitching by wrapping the thread around the needle two or three times (like a French knot) and then burying the end inside the doll.
- * *When you're closing the body, attaching limbs, or needle modeling, you will be pulling hard on the thread. To avoid cutting your hand, you may want to put a bandage or some adhesive tape on your index finger or wherever the thread might cut.*

Mrs.' Breasts

- Trace around the breast template (pattern piece **13**) onto a doubled piece of muslin. Use the **Dream Seamer** to trace a second line. Cut out on the cutting line.
- Stitch the dart in each breast.
- Trim seam allowance to 1/8-inch.
- Run a gathering line around the entire breast beginning at the dot at the top of the breast and ending at the second dot.
- Pull on the gathering threads slightly to form the breast.
- Put some stuffing in the breast.

- Pin the breasts to the chest. (They should be about midway between the shoulder and elbow.)
- * *Pin both breasts in place temporarily to get them positioned correctly. Then remove one breast while you work on the other one. Later, put the second breast back on and finish it.*
- Stuff breast until it looks as full as you want it to be.
- Ladder stitch the breast to the chest, adding more stuffing just before closing the seam.
- Tie off and loose the threads inside the body.
- Do the second breast.

Stuffing the Hands and Arms

You have your choice of stuffed or wired fingers. It is almost as easy, if not easier, to wire the fingers than to stuff them. Read all of the instructions before you make your final choice.

Stuffing the Fingers

If you are not ready to try wiring the fingers, or if you can't find chenille stems, you can stuff the fingers by following these instructions:

- Fold the arm down to form a cuff like a glove so that it is easy to work with the fingers.
- Wrap a small amount of stuffing around the small screwdriver stuffing tool like a cotton swab (or Q-Tip®).

- Slip the end of the tool into a finger.
- Pinch the finger to hold the stuffing in place while you pull the tool out.
- To add a knuckle, wrap a tiny bit of stuffing on the tool and slip it under the skin to the right place. Pinch the finger again and pull out the tool.
- * *Look at your own hands if you are not sure where to put the knuckle.*
- Stuff the hand lightly so that it doesn't get too thick.
- Stuff the wrist so that it is quite firm.
- Continue with the instructions for stuffing the arm later in this section.

Wiring the Fingers

It may be easier to wire the fingers than to stuff them.

- * *You must use chenille stems for wiring the fingers, not pipe cleaners. Pipe cleaners are too small.*
- Fold the arm down to form a cuff, like a glove, so that it is easy to work with the fingers.
- Using small wire cutters, craft scissors or kitchen shears, cut chenille stems into thirds.

- Use a small needle nosed pliers or your hemostats to bend the wires up approximately 1/16 inch on each end of each piece of chenille. Continue bending and press the end back into the chenille so you can't feel the sharp ends. This prevents sharp ends from puncturing the doll's skin.
- Bend each chenille piece in half. Don't pinch the bend too tight.
- Put a bent stem into the jaws of the hemostat lengthwise, with the rounded tip up. Grasp the finger to be stuffed between your thumb and forefinger and gently slip the chenille stem all the way to the end of the finger.



- Holding the tip of the wire inside the finger with your own fingers, unlock the hemostat and remove it.
- Stuff each finger this way.
- After all fingers and thumbs are wired, place a very small amount of fiberfill (about the size of a quarter, and not much thicker), into the palm of the hand. Before removing the hemostat, spread the stuffing by working the jaws back and forth a few times. Do not make the palm too fat.

- Turn hand over and do the same to the back of the hand.
- The thumb and perhaps the fingers may need a little more stuffing. Use the stuffing tool to add stuffing to fingers. Wrap a little stuffing on the tip and slide it under the skin to get the stuffing in the right place.
- To add a knuckle, wrap a tiny bit of stuffing on the tool and slip it under the skin to the right place. Pinch the finger again and pull out the tool.
- * *Look at your own hands if you are not sure where to put the knuckle.*
- You may wish to wrap the ends of the chenille stems all together with white floral tape before you begin stuffing the arm.
 - Grasp the back (wrist end) of the palm of the hand in the hemostats to keep the chenille stems in place. The hemostat will prevent the wires from being pulled out while you wrap the wires.
 - Pull the arm fabric down in a cuff to allow access to the wrist area.
 - Twist the chenille stems together above the wrist.
 - Wrap with white floral tape, stretching it as you go to activate the adhesive.

Stuffing the Arm

- Stuff the wrist so that it is quite firm.
- Just add more stuffing as needed, working up the arm to the elbow. It must be stuffed quite firm from the wrist to the elbow.
- Continue stuffing until you reach the shoulder area. The arm should be as firm as you can get it without popping the stitches. It should be about as firm as a ripe orange, or a "slicing" tomato, from the supermarket.
- When you finish stuffing the first arm, close it using the ladder stitch. Add more stuffing as necessary as you close the arm.
- Tie off the ends of the thread and lose the ends inside the arm.

Stuffing the Legs

Use the nesting technique for stuffing and the ladder stitch described previously.

Stuffing the Thigh

- Stuff the thigh (upper leg) until it is as firm as the body.
- Close with the ladder stitch.
- Lose thread ends inside thigh.
- Stuff and close other thigh.

Stuffing the Lower Leg

If the doll will be standing up, use some cardboard foot inserts to make the bottom of the feet flatter.

* *The back of a writing pad is the just about the best kind of cardboard to use. If you don't have one, glue several pieces of file folder together instead.*

- Using the appropriate boot sole template (pattern piece **10S** for the flat-heel boot, pattern piece **11S** for the high-heel boot, or pattern piece **12S** for the elf boot), trace two foot inserts on a piece of cardboard.

➔ Attention

Cut the inserts slightly smaller than the pattern piece (cut inside the lines) so that the insert will fit inside the boot.

- **For the elf boot only,** cut off about half of the long front tongue on the cardboard insole.

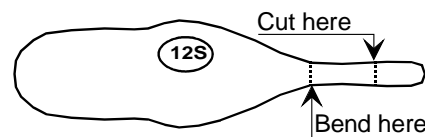

- For the elf boot only, bend the end of the insert so that it will follow the curve of the boot.
- For the high-heel boot only, bend the insert across the widest part so that it matches the shape of the sole.

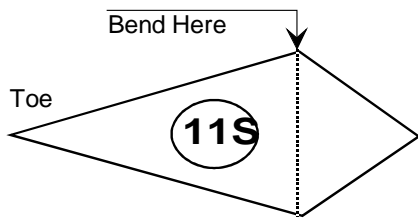

- Fold the upper part of the leg down into a cuff to make it easier to work with the foot.
- Grasp the heel of a foot insert in your hemostat, and slip it into the foot.
- * *The longer end of the insert goes into the toe.*
- * *Make sure the bend is facing the correct way. For the high-heel boots, the heel end is higher than the toe end. For the elf boots, the toe curls up. If it's not right, turn the insert over.*
- Work the foot insert around so that it fits exactly **inside** the seam allowance of the foot sole—the foot sole seams should stick up all the way around the foot insert instead of being underneath it.
- Grasp the foot insert through the outside of the doll's foot (just the last 1/4 inch) and lock the jaws of the small hemostat around it. This will keep the foot insert from creeping up the leg as you stuff the foot.
- With the foot insert grasped in the jaws of the hemostat, push fiberfill into the toe. Stuff the toe very firmly.
- When the toe and instep are firmly stuffed, you can remove the hemostat from the heel.

- As you stuff, shape the ankle with hard kneading so it doesn't look abnormally large.
- After you stuff the ankle, push more stuffing into the toe, arch and top of foot.
- * *Slide a small amount of stuffing just under the skin and deposit exactly where it needs to be.*
- * *A dark shadow is an air pocket that will eventually soften up. Add stuffing wherever you spot a shadow.*
- * *Be sure to smooth each deposit of stuffing with the jaws of the tool.*
- * *If you do get a lump, remove it with the tool and then build up the soft spot by adding a much smaller amount at a time.*
- * *Unless you are using **AIRTEX** Premium Bulk, do not re-use stuffing that you remove. Save used stuffing for a teddy bear where the lumps won't show.*
- Stop stuffing when you get to the bottom of the plastic insert.
- Fit the lower part of the thigh into the "sling" (top of lower leg) to see if it fits properly. Add or remove stuffing as needed.
- Cut an oval of muslin slightly larger than the opening at the top of the lower leg.

- Lay the oval of muslin over the opening and use your stuffing tool to force the edges of the oval between the leg "skin" and the stuffing.
- Use a needle or pin to put very small dots of white glue at several places between lower leg "skin" and the oval edge to hold it in place.

This method of stuffing takes quite a bit of time, but the result is a beautifully stuffed, smooth, strong doll that can command a better price.

Assembling the Doll

Assemble Leg

* Consult the Button Size Gauge (pattern piece 14) to determine the correct size button before assembling the legs.

- Place the thigh (upper leg) into the "sling" joint at the top of the lower leg so that it looks good both straight and in a sitting position. Use a pin through the joint to hold in place while you test rotation..

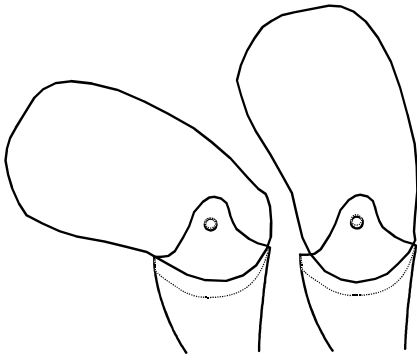

* The object is to find out where the joint should be on **your** doll. Ignore the pattern marking except as a rough guide.

- Mark the location of the joint on both sides of the thigh and both the inside and outside of both sides of the boot top.
- Double thread a 3-inch doll needle with about two yards of 100% nylon drapery thread. (There will be four strands about 18-inches long.)

- Begin at the mark on one side of thigh so that knot will be hidden. Stitch through the thigh, through the hole in the plastic insert, and through one hole of the button. (The button is turned upside down so that the flat side is out.)

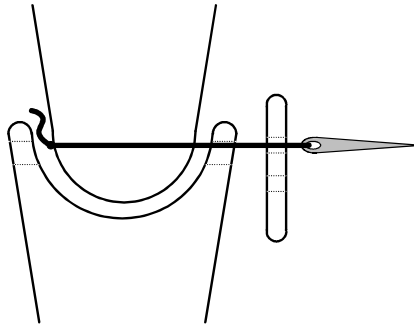

- Stitch back through other hole of button, through the hole in the plastic insert, through the thigh, through the hole in the other plastic insert, and through one hole of the second button.

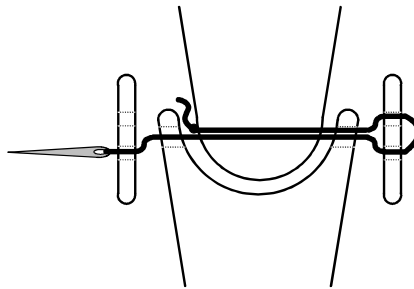

- Make two complete passes. (You should go through both holes in each button twice.)
- End just before going through the first button for a third time.
- Squeeze leg together and pull thread tight.

Mimi's Mr. & Mrs.

- Wrap thread around button several times knotting with each wrap.

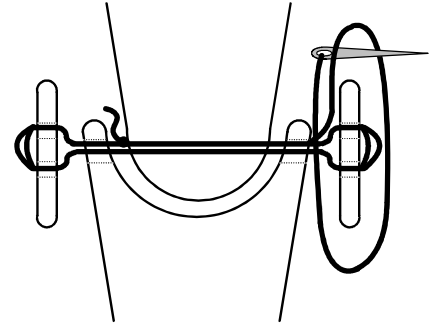

- Loose thread ends inside thigh.

Join Legs to Torso

* Consult the Button Size Gauge (pattern piece 14) to determine the correct size button before joining the legs to the torso.

- Place the legs on each side of the body using a long needle through both legs and the body to hold them in place. The object is to place the legs so that the doll looks good both standing and sitting.

➔ Attention

Be sure the toes are pointing in the same direction as the tummy.

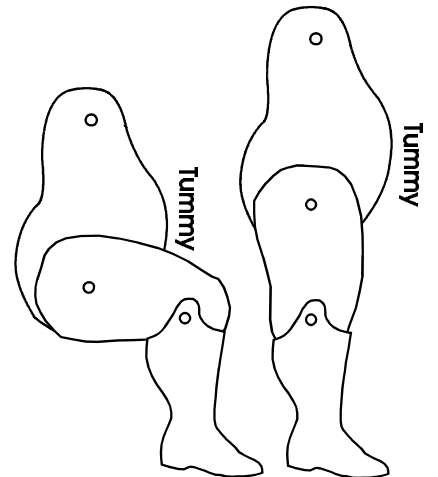

* *The object is to find out where the joint should be on **your** doll. Ignore the pattern marking except as a rough guide.*

□ Mark the location of the joint on both sides of the body and both the inside and outside of each thigh.

□ Double thread a 5-inch doll needle with about three to four yards of 100% nylon drapery thread. (There will be four strands about two to three yards long.)

□ Begin at the mark on one side of body so that knot will be hidden. Stitch through the body, through the thigh, and through one hole of the button. (The button is turned upside down so that the flat side is out.)

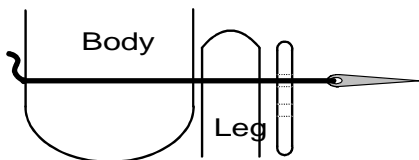

□ Stitch back through other hole of button, through the thigh, through the body, through the other thigh, and through one hole of the second button.

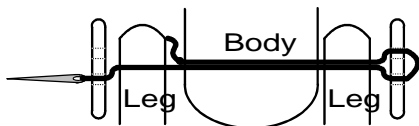

□ Make two complete passes. (You should go through both holes in each button twice.)

□ End just before going through the first button for a third time.

- Squeeze thighs and body together and pull thread tight.
- Wrap thread around button several times knotting with each wrap.

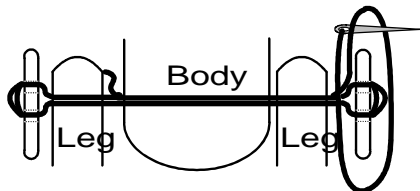

- Loose thread ends inside thigh.

Join Arms to Torso

* *Consult the Button Size Gauge (pattern piece 14) to determine the correct size button before joining the arms to the torso.*

- Place the arms on each side of the body using a long needle through both arms and the body to hold them in place.

→ Attention

Be sure the fingers are pointing in the same direction as the tummy and the thumbs are pointing up.

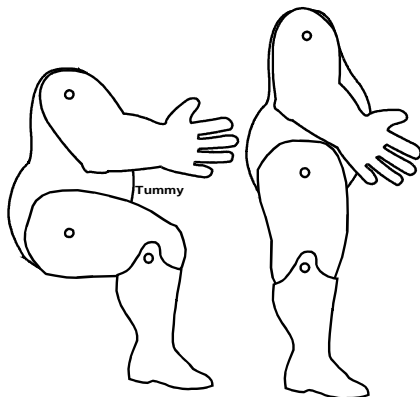

* *The object is to find out where the joint should be on **your** doll. Ignore the pattern marking except as a rough guide.*

□ Mark the location of the joint on both sides of the body and both the inside and outside of each arm.

□ Double thread a 5-inch doll needle with about three to four yards of 100% nylon drapery thread. (There will be four strands about two to three yards long.)

□ Attach the arms exactly the same way that you attached the legs.

Cover Buttons

* *Consult the Button Size Gauge (pattern piece 14) to determine the correct size buttons for the knees, arms, and legs.*

□ Place a spare button of each size on a piece of muslin and trace around it. Trace around it again using the **Dream Seamer**.

□ Make as many additional copies as you need.

- For knees, 4 covers.
- For arms, 2 covers.
- For legs, 2 covers.

□ Cut out the muslin circles.

□ Using a hand-sewing needle and the nylon drapery thread, gather each circle close to the edge.

□ Pull the thread tails to gather the circles slightly.

- Slip each circle over the appropriate size button and pull the thread tight.
- Wrap the ends in opposite directions around the button stem and then knot securely.
- Clip the threads.

Installing the Face

- Put some layers of stuffing into the back of the face.
- **For the Primary Face only**, pin open end of seam under chin of head. Spread open seam around neck and pin.
- Pin face on head, drawing up or letting out gathering threads as needed to fit head. Put pins 1/8 to 1/4 inch apart, all the way around face.
- * *To keep face straight, start pinning at chin and go up one side to forehead. Then return to chin, and pin up other side.*
- Slip small bits of stuffing between the pins until the face looks good. It should not be flat anywhere, nor should it have wrinkles.
- As an alternative, use your hemostat to place pom-poms (white-only) into face under a thinner layer of stuffing.
 - If you have not made the trapunto nose, use a 1/2" pom-pom for the nose.

- Use 3/4 inch pom-poms for the cheeks and chin.
- Hold the pom-poms in place with crossed pins until the face is stuffed enough to hold them.
- Experiment. Have fun. Make several faces and use the one you like best.

→ Attention

Make sure the face is well pinned. Do not stitch the face in place until after needle modeling. That way, if you do not like the face, you can remove it and make a new face.

Needle Modeling

If you feel adventurous, try some needle modeling.

Needle modeling is quite easy when you know how to do it:

- * **The first big secret** is that it doesn't matter what you do to the *back* of the head—the hair will cover your stitches.
- * **The second big secret** is *not* to pull the stitches too tight—only tight enough to hold.
- * **The third big secret** is that you push the face where you want it *with the tips of your fingers*, then you use stitches to hold it in place. *You do not pull the thread to model the face.*

- * *To start the thread, either take two or three stitches over the end of the thread and then clip it off; or, leave a long tail and wrap it around the needle after the first stitch (like a French knot), take a second stitch, and then clip off the tail. This is called a quilter's knot.*
- * *When appropriate, secure sculpting threads over a seam. It gives added strength and will prevent the stitches breaking through the fabric.*
- * *If you break the sculpting thread near the needle, put the end back into the needle and continue.*
- * *If you break the thread close to the work, put the end back into the needle, wrap the thread around the needle two or three times (like a French knot), and bury the thread end in the doll. Use a new piece of thread to continue.*
- * *Do not use wax on the sculpting thread. It will pull stuffing through with the thread and cause unsightly glitches. If you need lubrication to help prevent knots, use a drop or two of **Sewer's Aid** silicon or **Thread Heaven** (available in beading department or bead shops) on the spool of thread.*

* *To end the thread, wrap the thread around the needle two or three times (like a French knot) and push the needle through the doll. Clip the end of the thread where it comes back out of the doll.*

Now, let's do a little needle modeling.

- Thread a 3-inch doll sculpting needle with a yard-long, single strand of quilting thread knotted at one end.
- Beginning at the back of the head, push the needle through the head coming out at the inner corner of one eye.
- Take a tiny stitch and push needle under the stuffing and come out at the inner corner of the other eye.
- Squeeze the eyes together slightly and pull the thread. This defines the bridge of the nose.
- * *You don't have to pull hard—push the stuffing where you want it and snug up the thread to hold it there when you let go. Pull the thread near the doll, not near the needle. It won't break as often.*
- Do this a couple of times bringing the eyes a little closer together. Then come out straight through to the back of the head.
- Begin at back of head and stitch straight from the back of the head to the outer corner of one eye.

□ Take a tiny stitch and go back straight through to the back of the head.

* *Don't pull the thread when it is coming out of the front. When the thread is at the back of the head, push the eye in as far as you want it and snug up the thread by pulling gently.*

* *In general, push to shape, pull thread to hold in place.*

- Repeat the sequence until the thread holds the corner of the eye where you want it.
- Repeat on the inner corner of the same eye.
- From the back of the head take a stitch to the other side of the back of the head and stitch both corners of the other eye.
- With the thread at the back of the head, stitch to one corner of the mouth.
- Take a small stitch and come out near the top of the head on the same side.
- Gently pull on the thread until the mouth is slightly indented and has a small smile. Repeat until the thread holds.
- Take a long stitch to the other side of the top of the head and do the other corner of the mouth.
- Then stitch from the same corner of the mouth straight through to back of head.

□ Optionally, add several stitches from the lower part of the eye to the line that runs from the nose to the chin on either side. Do not pull these stitches too tight.

* *If you run out of thread take a tiny stitch or two on the back of the head to secure and lose the end inside the head. Thread with a new thread and continue.*

* *Knot the thread end that comes off the spool rather than the other end, if you pull the thread against the grain it will fray and break easier.*

□ End with the thread at the back of the head. Tie off and lose the threads inside the doll.

Be optionally adventurous:

- * *A few tiny stitches from the lines on the side of the mouth to the top of the head give even more definition to the face.*
- * *Try placing a few stitches around the top of the eye radiating out around the top and back of the head, this gives more depth to the eye and creates a forehead.*
- * *A few stitches from the bottom of the eye to the lower back of the head will round out the cheeks and further define the eye socket.*

- * You can further define the nose by taking a couple of tiny stitches from the top and bottom of each nostril straight through to the back of head.
- * You can add more stuffing to any part of the face by slipping the hemostats between the pins.
- * You can also add white pom-poms to the chin ($\frac{1}{2}$ -inch) and/or cheeks ($\frac{3}{4}$ -inch) after the mouth is modeled.

In Case of Disaster

- Pull out all the pins.
- Peel up the edges of the face.
- Snip the sculpting threads.
- Start over with the same face or a new one.

Attaching the Face

- When you are happy with the face, ladder stitch it in place to the front of the head.
 - Begin to ladder stitch at the chin. Stitch up to just above the eyebrow.
 - Tie off and begin again back at the chin dart and stitch the other side up to the eyebrow.
 - The top is left until last so you can add more stuffing. Stuff lightly until the face looks and feels right.
 - Finish stitching the face in place.

- * *Stitching this way will prevent the face from skewing all over the place.*

Adding the Ears

- Position the ears backwards on the head with the ear lobes even with the tip of the nose and the front edge of the ear about midway back on the head.

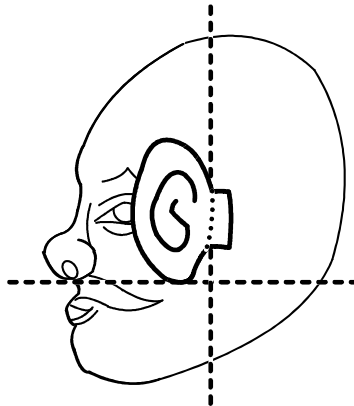

- Hand stitch the tab in place.
- Fold ears over so that they face correctly.

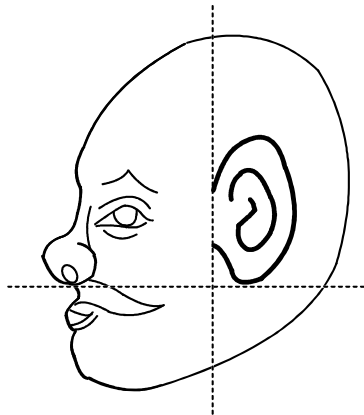

- Ladder stitch front edge of ear tab for a smooth join.
- Using dollmaking needle and about a yard of thread, go in at center back of head even with center of ears. Come out in center of one ear.

Mimi's Mr. & Mrs.

- Squeezing ears together, go across to center of other ear. Then go back to starting point at center back of head.
- Go around one more time and then tie off and bury thread ends.

Costume

When I dress a doll, I start with the stockings, then the shoes, the underwear, and the outerwear in that order. I dress the doll as each garment is completed. When the doll is completely dressed, I put it in a plastic bag and tie the bag tightly around the doll's neck. Then it's ready for hair without messing up all my hard work. If you do the hair first, believe me, you'll be sorry.

Mr.'s Costume

Mr. is dressed in a shirt, breeches and a vest. His vest is made from a scrap of ultra suede™, suede cloth or felt. None of these fabrics require finishing or lining and are, therefore, very easy to make.

Boots or Shoes

- Paint his boots with acrylic paint to coordinate with his outfit. Paint all of the lower leg and also the knee-joint buttons.
- * *Paint the boots before you put his breeches on. Make sure the paint is dry before dressing him.*
- Paint button covers to match or contrast with boots or shirt.

Shirt

- Trace the template for Mr. Shirt Front and Back (pattern piece 24) on fold of fabric. Trace two, one for the front and one for the back.
- Trace again using **Dream Seamer** for cutting line.
- On a doubled piece of shirt fabric, trace Mr. Shirt Sleeve (pattern piece 25). Trace again using the **Dream Seamer**.
- Cut out on cutting line.
- Mark slash line on one piece of shirt for front only.
- Cut a 3/4 inch by 5 inch bias strip from the shirt fabric.
- Stitch bias strip to front opening, right sides together. Stitch entire front opening. Snip to stitches at center "V".

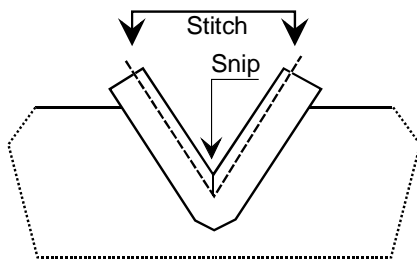

- Fold bias strip around shirt opening as shown in drawing and topstitch or whip stitch in place.

Cross Section

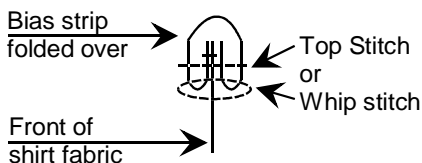

- Trim off excess bias strip above neck opening.

- Pin shirt front to shirt back at shoulders and stitch.
- Run a gathering stitch around the neck. Pull up gathers to fit doll's neck.
- To make a bias neckband, cut a strip of the shirt fabric 1-3/4 inches by 12-3/4 inches on the bias (or use ready made bias tape).
- Fold edges of bias strip in and press.

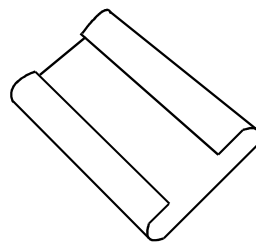

- Fold bias strip in half and press.

Cross Section

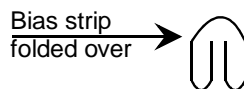

- Open out bias strip and pin center of bias strip at center back of neck opening.

Cross Section

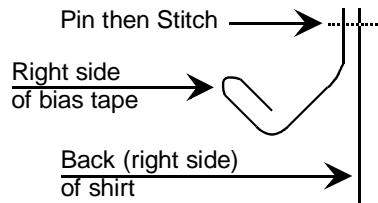

- Pin bias strip all around the neck opening, right sides together the ties will be hanging from either side of the front opening.

- Fold bias strip in around neck and top stitch or whip stitch only to end of neck opening. (Do not stitch ties.)

Cross Section

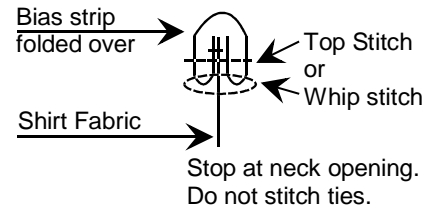

- About 1/4 inch from neck opening, open out the bias tape and snip the sides.

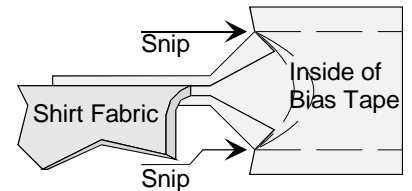

- Fold bias strip inside-out and stitch to end. Then stitch down end as shown in the drawing below.

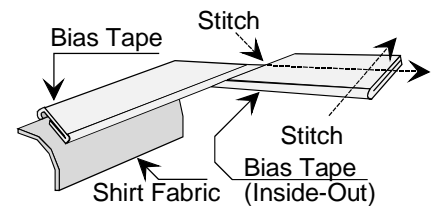

- Trim seams and turn with hemostats.

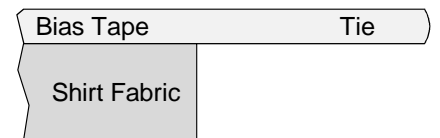

- Do other tie the same way.

Sleeve

- Stitch two rows of gathering threads around top of each sleeve.

- Stitch a row of straight stitches 1/4" from edge of sleeve bottom. Fold fabric in and press to wrong side.
- Narrowly hem wrist edge of sleeves. Roll folded edge up and inside as you machine stitch. The line of stitches will help to keep the hem even and narrow.
- Stitch two rows of gathers where indicated on pattern above wrist.
- Gather up to fit wrist and do a line of decorative stitching or stitch some trim over the gathers. This will make a nice ruffle for his wrist.
- Mark dots at shirt front and back for sleeve placement.
- Match dot at center of shirt sleeve with shoulder seam.
- Gather up sleeve to fit between dots.
- Pin sleeve in place and stitch. Trim seam.
- Set in other sleeve.
- Matching underarm seam, stitch along sleeve and down shirt side seam. Stitch other side.
- Narrowly hem bottom of shirt.
- Put shirt on doll and tie at neck. If you don't want a bow at his neck, cross ties in front, wrap around neck, and pin under chin.

Breeches

- Trace Mr. Breeches template (pattern piece 21) on doubled piece of fabric.
- Trace again with **Dream Seamer** for cutting line.
- Cut out on cutting line.
- Trace Mr. Waistband template (pattern piece 23) and Mr. Knee Band template (pattern piece 22) on single thickness of fabric.
- Trace again with **Dream Seamer**.
- Cut out on cutting line.
- Right sides together, stitch breeches center front seam together.
- Stitch center back seam leaving open above dot.
- Press seam allowances of center back opening under and whip stitch in place.
- Run two lines of gathering stitches at the waist and legs openings as indicated on pattern piece.
- Gather up leg openings to fit knee bands.
- Turn under 1/4 inch of long edge of knee band and press.
- Fold knee band in half lengthwise with pressed edge folded under. Press again.
- Turn band to wrong side and press short ends together. Turn to right side. Press.
- Machine or hand stitch rest of knee band closed.

- When breeches are fitted on doll snaps will be stitched in place to close knee bands around doll's knee.
- Gather up waist of breeches to fit waistband.
- Pin and stitch waistband in place.
- Turn up 1/4" of long end and press.
- Fold waistband in half and press again.
- Right sides together, stitch short ends of waistband closed. Turn and press.
- Top stitch waistband on right side to close.
- When fitted on doll a snap can be stitched in place to hold breeches waistband closed.
- Put breeches on doll. Either tuck shirt into breeches or let hang outside as tunic and tie a fancy cord around his waist if you like.

Vest

- The vest needs seam allowances only at shoulder seams and side seams.
- Trace the Mr. & Mrs. Vest Back template (pattern piece 41) on the fold of ultra suede or suede-like fabric.
- Trace Mr Vest Front template (pattern piece 26) on doubled fabric.
- * *If the fabric is not doubled, remember to trace one vest front and reverse the template to trace the other.*

- Add seam allowance with **Dream Seamer** only at shoulder and side seams.
- Cut out on cutting lines.
- Stitch vest front pieces to vest back at shoulder seams. Finger press seams open.
- Stitch vest front pieces to vest back at side seams. Finger press seams open.
- * *Finger press seams open by holding open seam in both hands and rubbing briskly along the straight edge of your sewing table a few times.*
- Trim vest as you wish and put vest on doll.
- * *You may wish to trim Mr.'s vest with tiny acorns or other natural found objects. A little tacky glue will hold them in place.*

MRS. Costume

Mrs. wears a chemise made from a soft cotton, she likes pretty print colors. Be sure the print is in scale.

Her chemise is trimmed in lace and has a lace ruffle at the hem that just peeks out under her overskirt. Her vest is trimmed in bright ribbon or metallic trim she has bartered from the fairies under yonder mushroom.

She likes bright colors so have fun choosing her fabrics. Her vest is also made from either ultra suede or felt.

Boots or Shoes

- Paint her boots or shoes with acrylic paint to coordinate with her outfit.
- **For Boots:** paint all of the lower leg and also the knee-joint buttons.
- * *Paint the boots before you put her breeches on. Make sure the paint is dry before dressing her.*
- **For Shoes:** If Mrs. is wearing high heeled shoes (rather than boots) the shoes will have to be painted. See the trim lines on the pattern and mark her shoes accordingly.
- Glue some appropriate trim around the edge of the shoe on the trim line.

Drawers

- Trace Mrs. Drawers template (pattern piece **32**) on doubled batiste and add seam allowance with the **Dream Seamer**.
- Stitch center back seam from crotch to circle.
- Trim seam at curves. Press open.
- Fold over raw edges on back opening and machine stitch a hem.
- Stitch center front seam. Clip at curves and press open.
- Right sides together, place narrow lace, raw edges together, on lower edge of drawers. This lace is upside-down. Stitch.

- Turn lace down and press. Top stitch with a straight, zig-zag or decorative stitch.
- * *If your machine does not zig-zag, turn under a narrow hem on bottom of drawers before adding lace.*
- Fold under 1/8" in waist edge of drawers. Press. Fold again along casing line and stitch.
- Match center front to center back seam and stitch inseam.
- Using a yarn needle, a tapestry needle or a bodkin, run a piece of string or crochet cotton through the casing. Put on doll, with opening at back, tie the string in a tight bow and cut off excess.

Chemise

- Trace two Mrs. Chemise Front and Back (pattern piece **33**), one front and one back, on fold of chemise fabric.
- Trace again using **Dream Seamer** and cut out on cutting lines.
- Trace Mrs. Chemise Sleeve template (pattern piece **34**) on a doubled piece of chemise fabric.
- Slash one Front/Back piece for front opening.
- Cut a 3/4 inch by 5 inch bias strip from the shirt fabric.
- Apply bias to front neck opening as for Mr's Shirt.

- Right sides together stitch chemise front to chemise back at shoulder seams.
- Gather up neck opening as for Mr.'s shirt.
- To make a bias neckband, cut a strip of the shirt fabric 1-3/4 inches by 12-3/4 inches on the bias (or use ready made bias tape).
- Apply bias neck band as for Mr.'s shirt.
- Apply ruffled lace to chemise hem the same way you applied the lace to the drawers.
- Add narrow flat lace to wrist edges of sleeves the same way you applied the lace to the drawers.
- On each sleeve, stitch a row of gathering stitches at the top as indicated on template.
- Either run two gathering lines or make a casing along wrist edge of sleeves.
- Gather top of each sleeve, pull thread up to fit between dots on chemise front and back.
- Gather lower edge of sleeve to fit dolls wrist or put 3 inches of baby elastic in casing and stitch ends together.
- Right sides together, matching dot to shoulder seam, pin sleeves into arm hole.
- Stitch and press toward the neck.

- Matching underarm seams, stitch down the sleeve and the chemise side seams.
- Put chemise on doll and tie ties into a pretty bow at neck.

Overskirt

- Tear or cut a strip of cotton fabric 3-3/4 inches by 22 inches.
- For the waistband cut a strip of fabric, on the straight of the goods, 3/4 inch wide by length of doll's waist measurement plus 3/4 inch.
- For the ruffle, cut a strip 1-3/4 inches by 44 inches. Sew short ends of ruffle together to make a circle. Fold in half lengthwise and press.
- Using two rows of gathering stitches, gather ruffle along doubled raw edges to fit hem of skirt.
- Apply ruffle to skirt hem using the same technique used to apply lace to the drawers and chemise.
- Turn ruffle down and press. Zig-zag or decorative stitch on the right side. This can be embellished with ribbon or trim.
- Stitch two rows of gathering stitches around top of skirt.
- Gather up to fit waistband.

- Pin right side of waistband to wrong side of skirt. Stitch in place. Trim seam, fold up and press.
- Fold in seam allowance at the top of waistband and press.
- Fold over hem allowance at each end of waistband and stitch.
- Fold waistband down its length so it covers the top edge of the skirt and press.
- Topstitch waistband to skirt on right side.
- Fit skirt on doll.
- Stitch closed or sew a snap on ends of waistband so skirt can be removed.

Vest

- The vest needs seam allowances only at shoulder seams and side seams.
- Trace the Mr. & Mrs. Vest Back template (pattern piece **41**) on the fold of ultra suede or suede-like fabric.
- Trace Mrs. Vest Front template (pattern piece **35**) on doubled fabric.
- * *If the fabric is not doubled, remember to trace one vest front and reverse the template to trace the other*
- Add seam allowance with **Dream Seamer** only at shoulder and side seams.
- Cut out on cutting lines.

- Stitch vest front pieces to vest back at shoulder seams. Finger press seams open.
- Stitch vest front pieces to vest back at side seams. Finger press seams open.
- * *Finger press seams open by holding open seam in both hands and rubbing briskly along the straight edge of your sewing table a few times.*
- Trim vest as you wish and put vest on doll.

Finishing

There are a few final things to do:

Hair

I have used all sorts of rovings, mohair, and beautiful colored and textured yarns for hair. I usually drape several colors and types of hair material on the doll after he/she is completely dressed. When I find one that looks perfect with the character and costuming, that's the one I use.

In the picture on the front of this pattern, Mrs. is wearing a purchased wig and Mr. has a long ponytail made from Mongolian Goatskin. His mustache is made from scraps of the same fur.

- Put the doll in a plastic bag and tie it tightly around his/her neck so that you don't get hair all over him/her.

- Drape and play with the hair material until it looks right.
- Sew or glue the hair in place.

Mustache

- To make Mr.'s mustache, cut some hair (whatever you are using as hair) and shape it in your fingers to form a shape similar to the mustache shape on the pattern piece.
- Tie the clump of hair in the center and stitch it just under the center of his nose with a short needle and regular thread to match the color of the hair.
- Use a small paint brush and paint some thinned tacky glue on the face in the shape of the mustache and press the hair into the glue. Let dry.
- You can take a little mustache wax or stiffener and twirl the ends of the mustache to make him really chic, suave and debonair.
- * *Low-temp hot glue, Grrrip glue, Fabritac, or Aleene's Thick Designer Tacky Glue works best for glued hair styles.*

Coloring the Face

- Use a fabric brush and apply cheek blush to cheeks and nose.
- Use a rose crayon or colored pencil for lips.

- Use pale lavender or light gray for eye shadow.
- * *Make up the doll's face as you would make up your own face. Use make-up sparingly and build it up until you are happy with it.*

Pricing Your Doll to Sell:

Take a good look at the finished doll and ask yourself these questions:

- ? Are you happy with it? Did you do a good job? Is it only okay, or is it excellent?
- ? What was your total cost of materials?
- ? What was the total time it took to complete the doll? (Keep in mind that the first time you make a new pattern it takes much longer.)
- ? How much are similar dolls going for in your area?
- ? Are you selling through a shop or gallery? If you are selling wholesale, your wholesale price should be about 50% of the retail price. You may be able to do better than this through a local store. If you are selling on consignment (you get paid only if the doll sells), remember that you may get the doll back unsold and dirty or shopworn from handling.

Usually a good rule of thumb is three times the price of materials plus whatever you want to get for your own work, or five times the cost of materials, and don't count your time.

If the doll sells easily, the price is probably right. If it attracts a lot of attention but doesn't sell, the price is probably too high. If you have more orders than you can fill, your price is too low.

Thank You

My thanks to all of you who have purchased this pattern. I sincerely hope that you not only enjoy making *Mimi's Mr & Mrs*, but that you also learn more about dollmaking from making them.

Happy Dolling,

Mimi

Making Mimi's Stuffing Tool

I frequently make dolls without clothes to show off just how good a cloth doll can be. It's not that I particularly like nude dolls—it's that I don't want the clothing to hide my work. So, as you have probably noticed, I'm a little bit crazy about stuffing smoothly.

I have described earlier how I use the nesting technique either with my fingers or with a hemostat. I also use a specially designed stuffing tool in two ways:

- * *I wrap the tip of the tool with stuffing like a cotton swab and slide stuffing under the skin to fill in exactly where I want it. This is the technique I use for filling in low spots in the body or face, and for adding knuckles to the fingers.*
- * *I use the tip of the stuffing tool to straighten seams. It will slip under the skin and I can turn the seam allowance all in the same direction for a smoother appearance.*

The stuffing tool that I use is a **Stanley 64-846** screwdriver with a wooden drawer knob attached to the handle so that it doesn't hurt my hand. It has a 1/8-inch wide blade without any "ears." You can use the screwdriver "as is" from the store, but hours of use will rub blisters on your hand. The knob makes it much more comfortable to use.

You can find both the screwdriver and the knob in most hardware stores, and it is not hard to assemble them.

Materials and Tools

- 1/8" screwdriver without "ears"
- Round Knob, Finish Natural, 1 1/4-inch diameter
- Electric drill with 11/64-inch drill bit
- 5-minute or 10-minute epoxy glue
- Pliers
- Hacksaw and vise

Instructions

- Cut the head off of the screw supplied with the knob. Put the screw into a vise to hold it and use a hacksaw to cut it off at the end of the threads as shown in the following drawing.

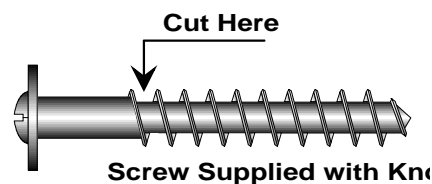

- Drill an 11/64-inch diameter hole 1/2-inch deep in the end of the screwdriver handle.

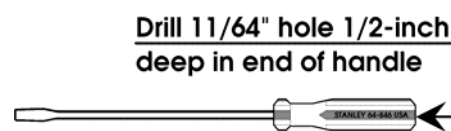

- * *My husband Jim uses a drill press to make my stuffing tools, but you can do it with an electric drill if you are careful to keep the*

drill straight. It helps if you use a center punch to mark where the hole will go so that the drill bit doesn't wander.

▲ CAUTION

Do not hold the screwdriver in your hand while drilling the handle. Use a vise or pliers to hold it.

- Mix up some quick-setting epoxy glue.
- * *Use any glue that will join metal to wood (the screw and the knob) and metal to plastic (the screw and the screwdriver handle) without requiring air to dry.*
- Put a little epoxy on the threads on the cut end of the screw or in the hole in the knob.
- Using the pliers, screw the cut-off end of the screw into the knob as far as it will go. It should stick out about 3/8 of an inch.

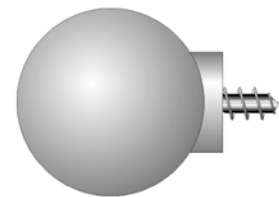

- Put a little epoxy onto the end of the screw sticking out.
- Screw the knob into the hole in the handle of the screwdriver as far as it will go. (Use the pliers to hold the screwdriver handle.)

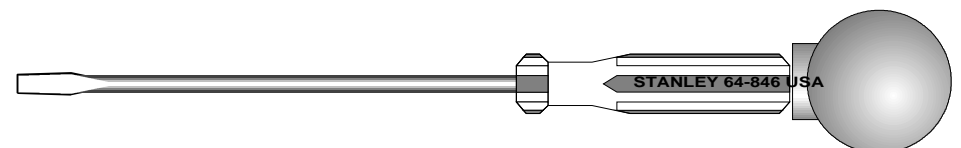

32 Appendix B

Easy Face Instructions

These same face instructions are in many of my patterns.

On most of my dolls, only the eyes are painted. The lips are colored with colored pencils and the eyebrows are drawn with a fine point marker by Sakura.

Eye painting instructions are given here. If you prefer to embroider the eyes, instructions are given on the next page.

Painting Without Brushes

If you are not comfortable using paint brushes, don't. There are many lovely new pens and colored pencils available today. I frequently use **Berol** colored pencils or **Sakura's Pigma** fine point pens. These are color fast and will not bleed if you use a light touch.

* *If you use the .01 fine tip pens, never use them on fabric that has been treated with gesso, **Createx**® or any fabric medium. The point will clog. (You can sometimes rescue a clogged point by soaking the point in alcohol.)*

* *Store your pens and felt tip markers on their sides rather than standing upright, they won't dry out so quickly.*

* *If you use colored pencils, use a light coating of **Createx** fabric medium after you've finished to make them permanent.*

You can use the eye painting instructions using colored pencils, fine line fabric pens, or crayons with sharp points. Use one color over the other rather than mixing paint.

Painting the Eyes

Use acrylic paints designed for fabrics, or use artists' acrylic paints mixed with textile medium. These instructions are for blue eyes. For brown or green eyes, use the appropriate colors.

* *Place the face on a piece of fine sandpaper to keep it from sliding around while you are painting.*

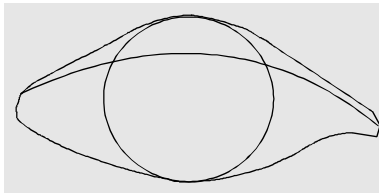

- Mix a small amount of burnt umber, some white, and a few drops of water on a paper plate. The final color should be just a little darker than the doll's skin. Load a small round brush (#0 or #1) and paint the eye lid.

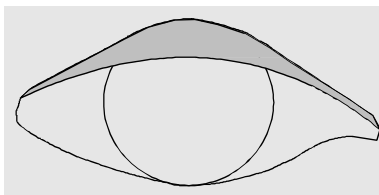

→ Attention

Be sure to allow each coat of paint to dry before adding another color. (I keep a hair dryer in my studio for this purpose.)

Mimi's Mr. & Mrs.

- Mix a small amount of cobalt blue with a few drops of water on a paper plate. Load a small round brush (#0 or #1) and paint the entire eye circle.

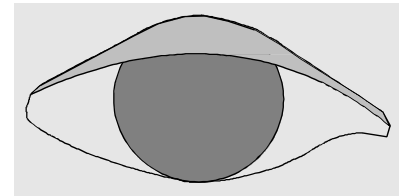

- Paint the eye outside the eye circle solid white.

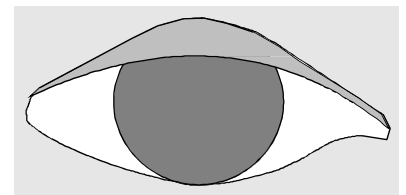

- Mix a very tiny speck (about the size of the head of a pin), of burnt umber into some of the blue. Paint on the eye circle only, far enough down to cover the upper one-third of the eye circle (including the part under the eyelid). This is the shadow under the eyebrow. (This shadow does not show on the white part of the eye.)

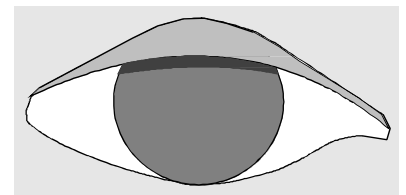

- Mix a little more burnt umber (about three times what you mixed before, about the size of a pencil eraser) into the blue. Use a fine liner brush or the business end of a pin to draw around the front edge of the eye lid. *Do not* draw around the bottom eye lid.

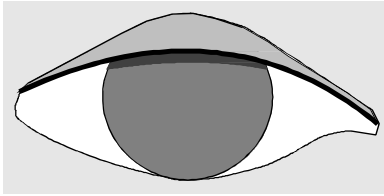

- Here's an easy way to make a perfect pupil. Using a small circle template from the stationary store, find a circle that seems right for the eye and draw it on the painted eye with a pencil.

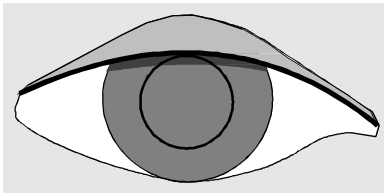

- Fill in the circle. I use a Sumi pen or mix more burnt umber with cobalt blue until it's very dark. The mixed paint looks better than black paint.

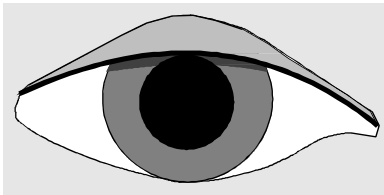

- Mix a little white into the first blue until it is a sky blue color. Use the small round brush to paint a tiny crescent on the iris outside each side of the pupil, between 4 and 5 o'clock and between 7 and 8 o'clock.

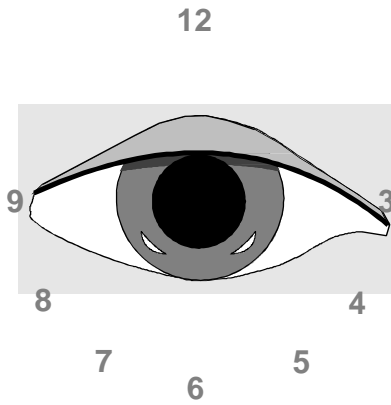

- Using the sharpened point of a pencil that has been dipped in a small drop of white paint, place a white dot just inside the edge of the pupil at two or ten o'clock to make the eye light.

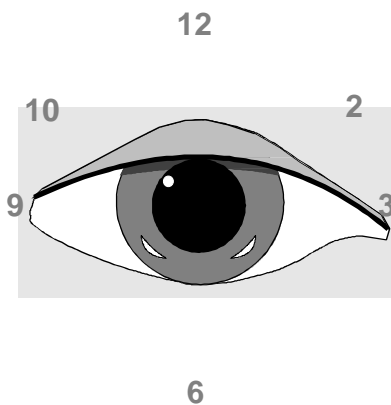

- When the paint has completely dried give the whole eye a coat of acrylic gloss or clear nail gloss.

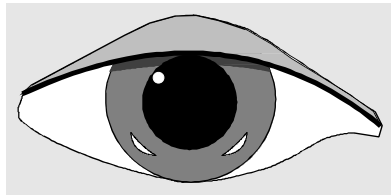

Embroidering the Features

If you prefer, embroider the face before cutting it out. It is easier to put a larger piece of fabric into your embroidery hoop. Cut the face out after the eyes have been stitched.

- Use two strands of floss and satin stitch the entire eye in white.
- Then satin stitch the iris in blue and the pupil in black.
- Satin stitch the crescents and eye light as described under painting instructions.
- Outline stitch the top of the eye with brown thread.
- The eyebrows are done in outline stitch.

Your Notes:

Doll:

Piece	Description
1	Mr. Primary Face—Cut 2 of muslin
1T	Mr. Primary Face Trace—Trace only
1A	Mr. Alternate Face—Cut 1 of muslin
2	Mrs. Primary Face—Cut 2 of muslin
2T	Mrs. Primary Face Trace—Trace only
2A	Mrs. Alternate Face—Cut 1 of muslin
3E	Elf Ear—Cut 4 of muslin
3H	Human Ear—Cut 4 of muslin
4B	Bent Arm—Cut 2 of muslin for each
4S	Straight Arm—Cut 2 of muslin for each
5	Thigh—Cut 4 of muslin
6	Body Side—Cut 2 of muslin
7	Body Back Gusset—Cut 2 of muslin
8	Body Front Gusset—Cut 2 of muslin
9	Boot Facing—Cut 4 of muslin,—Cut 4 of plastic
10	Mr. Flat-Heel Boot—Cut 4 of muslin
10S	Mr. Boot Sole—Cut 2 of muslin, cut 2 of cardboard
11	Mrs. High-Heel Boot—Cut 4 of muslin
11S	Mrs. Boot Sole—Cut 2 of muslin, cut 2 of cardboard

12	Elf Boot—Cut 4 of muslin
12S	Elf Sole—Cut 2 of muslin, cut 2 of cardboard
13	Breast—Cut 2 of muslin for Mrs. only
14	Button Size Gauge—Reference only

Costume:

Piece	Description (Mr.)
21	Mr. Breeches—Cut 2
22	Mr. Knee Band—Cut 2
23	Mr. Waist Band—Cut 1
24	Mr. Shirt Front and Back—Cut 2 on fold
25	Mr. Shirt Sleeve—Cut 2
26	Mr. Vest Front—Cut 2
41	Mr. or Mrs Vest Back—Cut 1 on fold
Piece	Description (Mrs.)
31	Mrs. Miscellaneous—Reference only
32	Mrs. Drawers—Cut 2
33	Mrs. Chemise Front and Back—Cut 2 on fold
34	Mrs. Chemise Sleeve—Cut 2
35	Mrs Vest Front—Cut 2
41	Mr. or Mrs Vest Back—Cut 1 on fold

Sources

Airtex Consumer Products

Airtex Premium Bulk stuffing
800-851-8887
Wholesale and retail
<http://airtex.com/>

Barbara Willis Designs

Stuffing forks
415-962-0639
Wholesale and retail
<http://www.barbarawillisdesigns.com>

Clotilde

Sewing supplies and notions
800-772-2891
Wholesale and retail
<http://Clotilde.com>

Createx Colors

800-243-2712
Wholesale
<http://www.createxc colors.com/>

The Compleat Sculptor

Anatomical Models
Retail
<http://www.sculpt.com/>

CR's Crafts

Airtex Premium Bulk stuffing,
dollmaking needles,
fabric, **Paperclay**
515-567-3652
Retail
<http://crscrafts.com/>

Dollmakers Journey

Fabric, needles, **Createx**,
Grrrip Glue, Needle-pointed glue dispenser,
Dream Seamer,
hard-to-find dollmaking supplies
703-569-7072
Retail
<http://www.dollmakersjourney.com>

Mimidolls.com

G Street Fabrics

Rockville, MD
800-333-9191
Swimsuit lining, all fabrics
Retail
<http://www.gstreetfabrics.com>

HarborFreight

Inexpensive tools
800-423-2567
Retail
<http://HarborFreight.com>

Joggles.com

Fabrics, trim,
goodies for fabric artists and dollmakers,
on-line classes
Retail
<http://Joggles.com>

Kreinik

Gorgeous threads for embellishment.
Wholesale
<http://www.kreinik.com/>

Mimidolls.com

Books & Patterns by Gloria J. "Mimi" Winer
Wholesale and retail
<http://Mimidolls.com>

Piecemakers Country Store

Doll Sculpting Needles
Wholesale and retail
<http://www.piecemakers.com>

Quilter's Resources

(now Brewer Quilting & Sewing Supplies)
Piecemakers and **Nifty Notions** doll sculpting needles
Wholesale
<http://www.brewersewing.com>

Materials & Supplies

For Dolls:

- 1 yard good quality muslin for body (can be tea dyed or **Rit** dyed for a dark skinned doll.
- Matching thread
- Air soluble marker (purple)
- Dream Seamer** (available at quilt shops)
- Grrrip** glue and needle tip dispenser (available at DollmakersJourney.com)
- 5-1/5 inch straight Kelly hemostat for turning fingers and for stuffing
- Stuffing tool made from small screwdriver
- Cardboard for boot or shoe inserts
- Hand sewing needles-sharps or milliners
- 3 and 5 inch and 7 inch doll sculpting needles
- Quilting thread to match fabric
- Hair: 1 yard roving or one foot roving braid or any textured yarn. Your choice of color with thread to match
- Purchased wig for Mrs.
- Buttons for jointing dolls: FOR EACH DOLL:
 - Two-1-1/4 inch buttons for hip joints
 - Two one inch buttons for shoulder joints
 - Four 3/4 inch buttons for knee joints
- one CoolWhip™ top or plastic milk container for knee joint interfacing

For Finishing Face:

- Berol**® Colored pencils or fine point fabric pens, medium blue, rose, brown
- Powder blush in pink or peach, For a brown skinned doll use terra-cotta and make the eyes brown rather than blue
- Acrylic paint (optional) white, cobalt blue, burnt umber
- Embroidery floss (optional) lt. brown, blue, black, white

For Stuffing Doll:

- Optional stuffing tool, 8 inch clamp or hemostat for stuffing legs around armature
- Polyester fiber stuffing material, two bags.

For Wired Fingers or Optional Hand Armatures:

- 5 white 12 inch chenille stems for fingers (for each doll) (available at craft shops)
- White floral tape (available at the craft shops)

Miscellaneous:

- Several manila file folders
- Paper scissors
- Glue stick for paper (not a stick meant for the glue gun)

Mr. Costume:

- 1/2 yard soft cotton for shirt
- Thread to match.
- 1/2 yard suede like cloth for breeches
- Thread to match
- Four small snaps for knee bands and waistband
- For vest, seven inches ultra suede™ or 1/4 yard felt
- Thread to match
- One yard trim or found objects such as small acorns or pieces of pine cones for vest trim
- Thread to match

Mrs. Costume:

- 1/2 yard batiste for drawers
- 1 yard crochet cotton for drawstring
- Thread to match
- 1/2 yard narrow flat lace
- 1/2 yard soft cotton for chemise
- Thread to match.
- 1 yard 3/4" ruffled lace
- 1 yd narrow flat lace
- 1/2 yard cotton print or solid for skirt
- Thread to match
- Two small snaps
- Seven inches ultra suede or 1/4 yd felt
- 1 yd trim